

MasterLine

MKN MasterLine



Premium equipment



MKN MasterLine

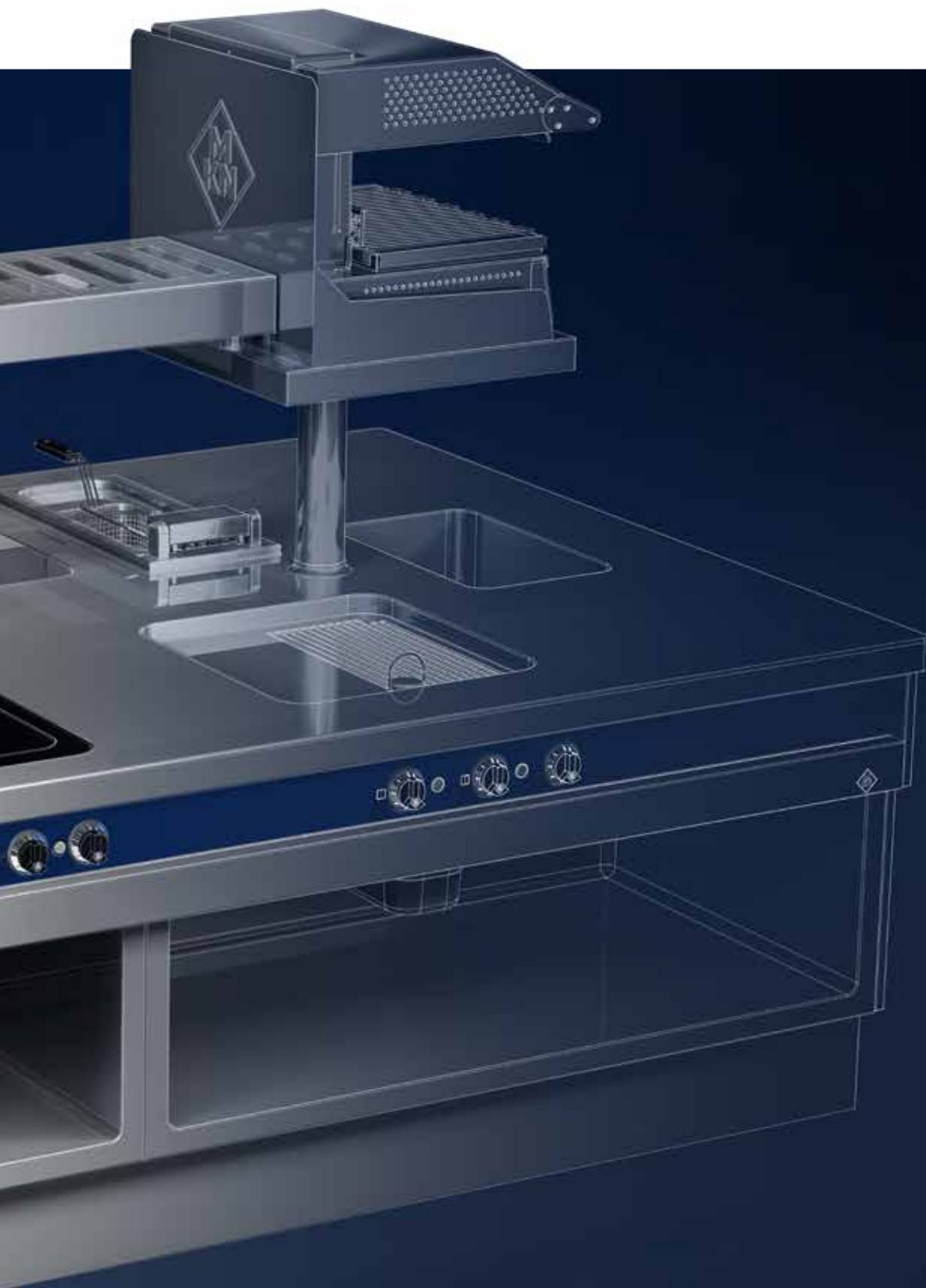

Perfectly combined

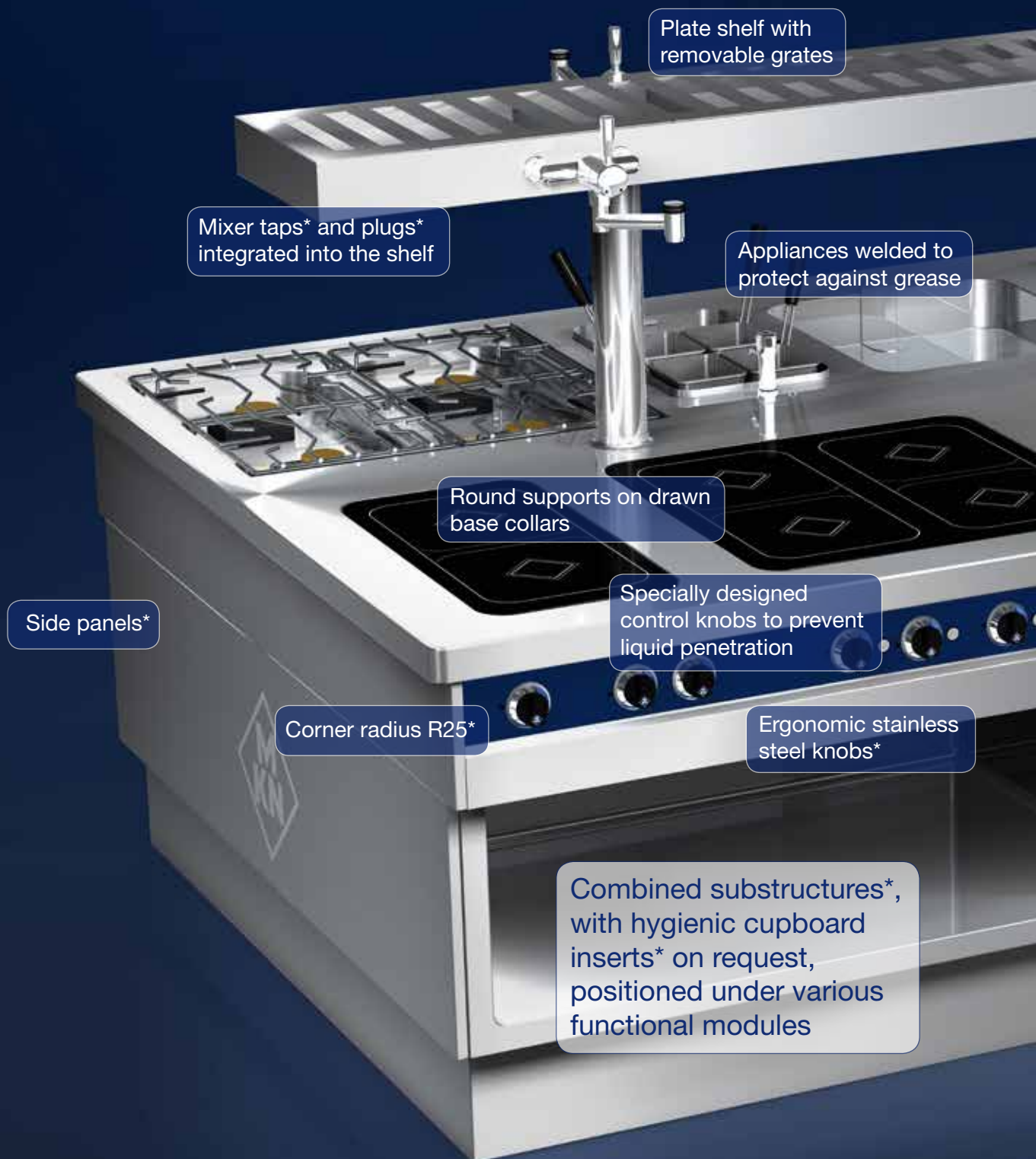

MKN MasterLine

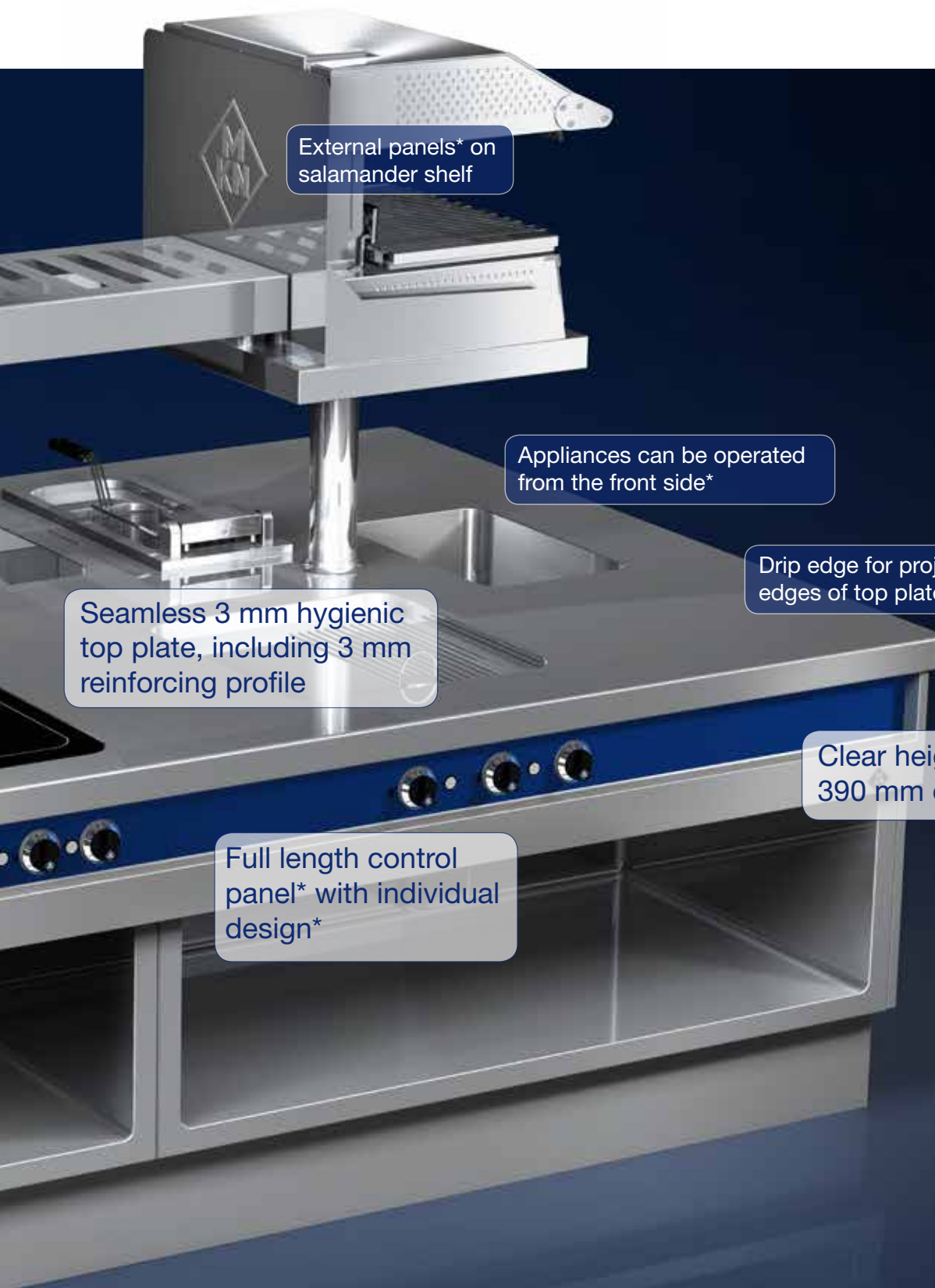

External panels* on salamander shelf

Appliances can be operated from the front side*

Drip edge for projecting edges of top plate

Seamless 3 mm hygienic top plate, including 3 mm reinforcing profile

Clear height 390 mm or 490 mm*

Full length control panel* with individual design*

MKN MasterLine

First class quality for
gourmet cuisine



**Compact, powerful and individually
designed**

MKN MasterLine is masterfully adapted to the requirements of the top level gastronomy sector. This exceptional equipment, featuring outstanding hygiene and design, knows what counts every single day, and that's to produce top food quality fast and easily alike.

**MKN quality
made in Germany.**



Just the way you want it!

360 MKN electric and gas appliances can be individually combined under a single top plate.

Single line or double line installation. Mounted on a plinth provided by the customer, on appliance feet or on a stainless steel plinth*.

Impressive down to the last detail



Appliances welded to protect against grease

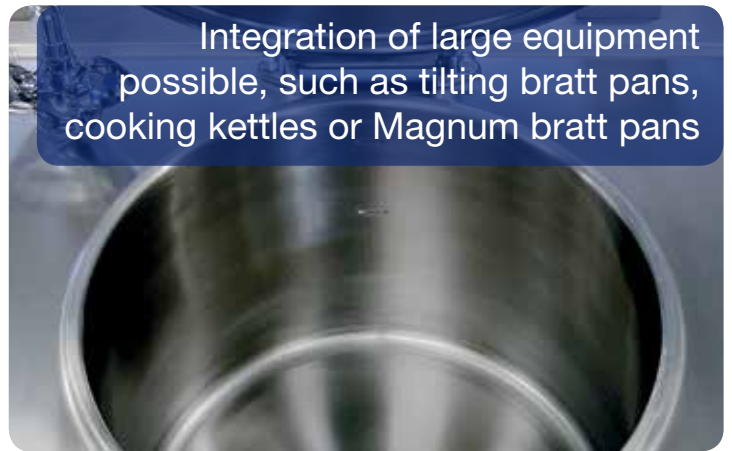

Integration of large equipment possible, such as tilting bratt pans, cooking kettles or Magnum bratt pans



Deep fat fryers, pasta cookers and cookmaries on a seamlessly canted base

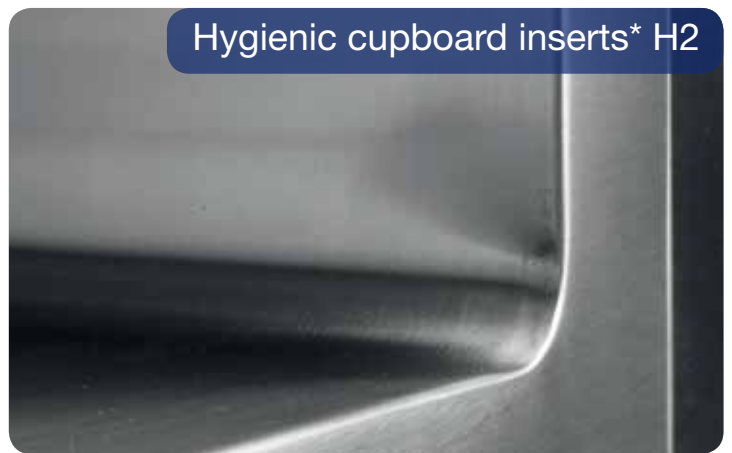

Hygienic cupboard inserts* H2



Seamlessly welded frying plates



Handrails* in round or rectangular design, fully welded

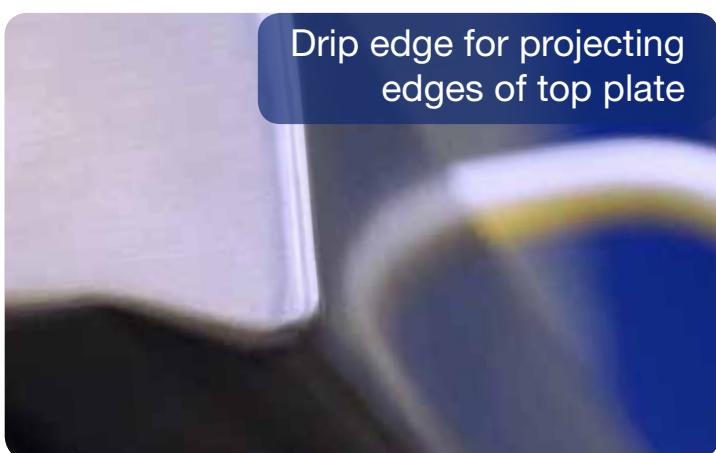

Drip edge for projecting edges of top plate

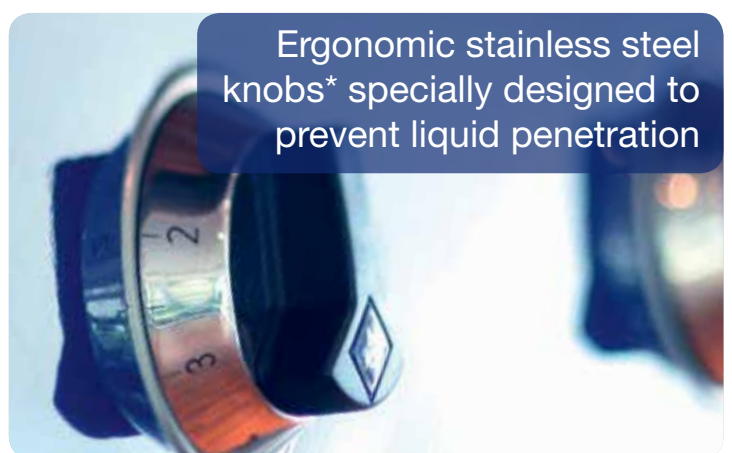

Ergonomic stainless steel knobs* specially designed to prevent liquid penetration

* optional equipment

MKN MasterLine



Integrable appliances

- Electric induction ranges
- Electric induction woks
- Electric Vitro ranges
- Electric ranges with multizone hobs
- Electric hot plate ranges
- Electric deep fat fryers
- Electric infra chip scuttles
- Electric griddle plates
- Electric griddle pans
- Electric bainmaries
- Electric cookmaries
- Electric pasta cookers
- Electric infrared chargrills
- Electric tilting bratt pans
- Electric bratt pans Magnum
- Electric quick boiling kettles, round
- Electric quick boiling kettles, rectangular
- Electric baking ovens
- Gas ranges
- Gas solid top ranges
- Gas griddle plates
- Gas lava stone grills Argentina
- Gas tilting bratt pans
- Gas quick boiling kettles
- Gas baking ovens

Cooking block design

- Single line cooking blocks
- Single line cooking blocks, operation from both sides
- Double line cooking blocks
- Functional modules on the front side
- Folded up edges
- Folded down edges
- Preparations for plug seams or weld seams
- Widening of the top plate
- Installation on appliance feet
- Installation on plinth provided by customer
- Installation on MKN stainless steel plinth
- Plate shelf with round supports
- Lowered salamander shelf
- Ladle racks on shelf
- Mixer holder on shelf
- Handrail in round design
- Handrail in rectangular design

Options

- Corner design R25
- Full length control panel
- Full length coloured control panel
- Ergonomic stainless steel knobs
- Integration of sockets
- Integration of mixer taps
- Internal height of vacant substructures raised by 100 mm
- Side panels
- Coloured side panels
- Combining of substructures
- Hygienic cupboard inserts H2
- Full length hygiene cupboard inserts in single line blocks
- Central terminal or fuse box



Premium quality every day. Worldwide.

Whether it be in first class hotels and restaurants, commercial catering, gourmet gastronomy or system catering, MKN is at home in the world's best kitchens.

The German premium manufacturer of professional cooking technology sets new standards with innovative products featuring outstanding practicality, durability and cost effectiveness.

MKN's recipe for success is more than 70 years of experience, competence and close cooperation with professional chefs.

